

SOLUTIONS  
FOR ALL  
SPACES



**alex**

# OUR HISTORY

## Furniture manufacturing with over 32 years experience

Alex Furniture was established in 1991 and shortly after became the market leader in Hungary for school furniture manufacturing.

Over the years our product portfolio has expanded from producing school desks and chairs to offer nursery, outdoor, hotel-gastro, office and changing room furnitures.

Main focus on furniture manufacturing is based on metal frames and laminated chipboards. The manufacturing consists of a Locksmith with

Laser & Plasma cutting, welding, bending and punching machinery, a paint shop for electrostatic powder coating, carpentry, upholstery and assembly.

We support furniture manufacturers, distributors and furnishing companies with our own product range as well as to design and produce customised furnitures. We are EN ISO 9001 certified.

Our factory site is located about 20km west to Budapest and close to the E75 Highway.

## The School as a learning- and living space

The furnishing of a school classroom is very important as the kids spend almost a whole day in the school. Our different classroom concepts, consists of cosy, ergonomic fixed and height adjustable furnitures with a wide variation of colors, to provide many possibilities for the ideal furnishing solutions for any school.

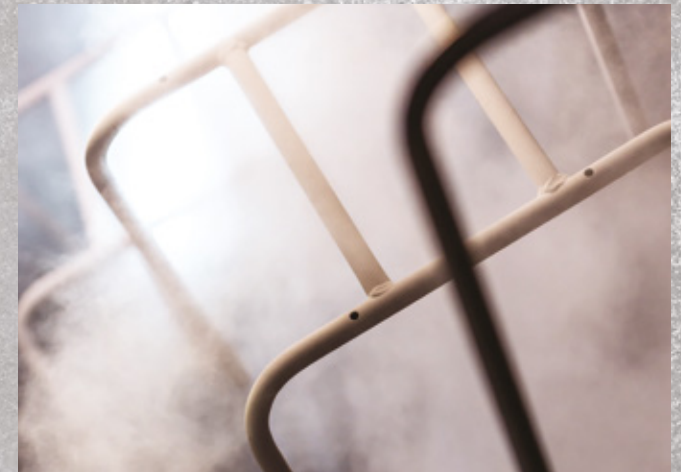
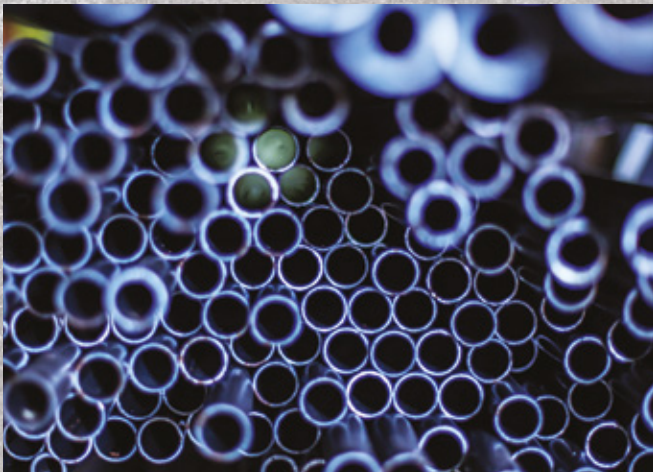
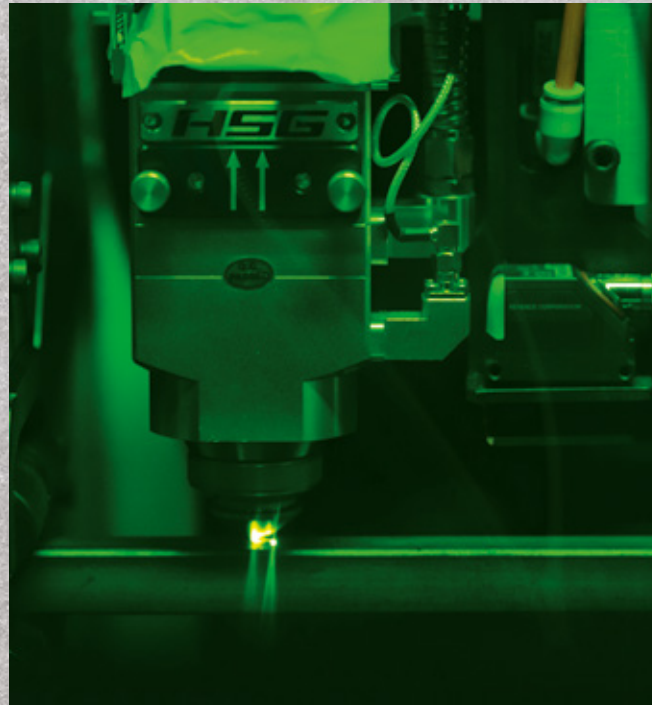

**Cutting of tubes and profiles**

(max. Ø90 mm)

**Bending of tubes and profiles**

with bending machine and 3D  
CNC bending machine  
(max. Ø60 x 5 mm)

**MIG/MAG welding**

by „hand“ and also  
with welding robots

**Carpentry works**

with wide range of raw  
material (HPL boards,  
chipboard, plywood, etc.)

**Electrostatic plastic powder-coating**

(max. size 800x1200x2000 mm).  
The coating can be made for  
outdoor or indoor use.



**alex**

# CONTENT

<b>7</b>	<b>HEIGHT ADJUSTABLE</b>	
	<hr/>	
	PRODUCT COLLECTIONS	
	• FLEX JUSTY	8
• JUSTY TRAPEZOID AND HEXAGON	10	
• KEX	12	
<b>15</b>	<b>FIXED HEIGHT</b>	<b>FRONTAL EDUCATION</b>
	<hr/>	
	PRODUCT COLLECTIONS	
	• KEX FIX	16
	• GEO LINEA	18
• GEO SPECIAL	20	
• ATLAS	22	
<b>25</b>	<b>FIXED HEIGHT</b>	<b>GROUP EDUCATION</b>
	<hr/>	
	PRODUCT COLLECTIONS	
	• FRISBEE	26
	• FLEX	28
	• TRAPEZOID AND HEXAGON	30
	• SMART CLASSROOM	32
	• KALEIDO	34
	• PITAGORAS	36
• PUZZLE WAVE	38	

**41** **TEACHERS**  
DESKS AND CHAIRS

**45** **FLEX CABINETS**  
WITH GRATNELLS DRAWERS

**47** **CLASSIC**  
CABINETS

**49** **SCHOOL**  
BOARDS

- CLASSIC BOARDS 50
- VARIO WALL BOARDS 52
- BOARD STANDS AND MESSAGE BOARDS 54
- MODULAR DISPLAY SYSTEMS 56

**59** **SPECIFIC CLASSROOM**  
FURNITURES

- SCIENCE - LAB 60
- ARTS WORKSHOP - FURNITURES 62

**65** **OFFICE**  
FURNITURE

- PONTIS CABINETS 66
- PONTIS DESKS AND TABLES 68
- FLYNN DESKS 70
- ELEX STRONG DESKS 72

**75** **RELAX - WORK CAFE**  
CANTEEN AND COFFEE STATION

**79** **MODULAR STORAGE FURNITURE**  
CUBE LOCKER

**83** **LOCKERS**  
MELAMINE FACED CHIPBOARD

**85** **FITT LOCKERS**  
WITH SHOE STORAGE AND CHIPBOARD

**89** **COMMON AREA**  
LOUNGE FURNITURES

- PONTIS 90
- BEAN 92
- DOMINO 94
- ATLANTA 96
- VITAL 98
- BUBBLE 100
- DURAN 102
- KOLD 104
- KALEIDO 106

**109** **DINING**  
CANTEEN FURNITURE

- KALEIDO 110
- BETA 112
- FLEX 114
- REAL 116

**119** **AGE GROUP CHART**  
MATERIALS AND COLOURS



**HEIGHT  
ADJUSTABLE**

PRODUCT COLLECTIONS



## HEIGHT ADJUSTABLE

FURNITURE FOR YOUR INSTITUTION

By height adjustability of chairs and desks the optimum sitting comfort can be adapted to various students heights. They are stackable, makes the use more versatile, and the space can be used more efficiently.

Nowadays in addition to frontal teaching, group work, games or other events that require movement are more common.



FLEX JUSTY



This is one of our newest product lines. During the development we have focused on the high variability of usage, and the result gives several options of placing tables in different forms together.

### FLEX DESKS FOR ONE OR TWO PERSONS



*FLEX*  
teacher's desk  
with drawers



*FLEX*  
adjustable height  
school chair



*FLEX*  
school chair,  
with adjustable  
height footrest



*FLEX*  
office chair



JUSTY TRAPEZOID AND HEXAGON

## IDEAS FOR SPACE PLANNING

The height adjustment function of our Justy trapezoid and hexagon tables are built on telescopically sliding tubes.

Adaptive furniture for project-based learning, student-centred and active learning.

Because of the characteristics like stacking, row formation and height adjustability of our trapezoid and hexagon desk your space can be reorganised in moments to the desired configuration.

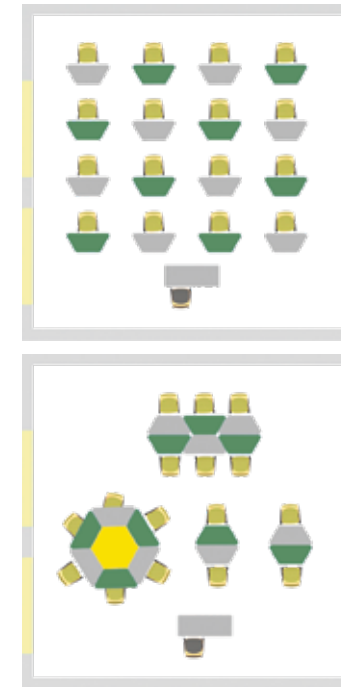

*JUSTY TRAPEZOID DESK*  
2 seats, height adjustable,  
stackable, arrangible in a row



*JUSTY TRAPEZOID DESK*  
with castor, 1 person, adjustable,  
stackable, arrangible in a row



*JJUSTY HEXAGON DESK*  
for 1 person TRAPEZE desks,  
height adjustable



KEX

## KEX DESKS FOR ONE OR TWO PERSONS

This collection has a height adjustable desk and a stackable chair which is made of 38x20 mm flatoval steel tube, the seat and backrest are made with form pressed plywood.

Desk legs are made by a 50 x 25 mm flatoval tubes.

The legs of the desks and chairs are height adjustable with a telescopic „tube-in-tube” solution.

height adjustable by age group, stackable chair frame

beech plywood seat and backrest

table top with rounded corners

height adjustable table frame by age group

plastic floor gliders

Optionally available, chair or book holder rack

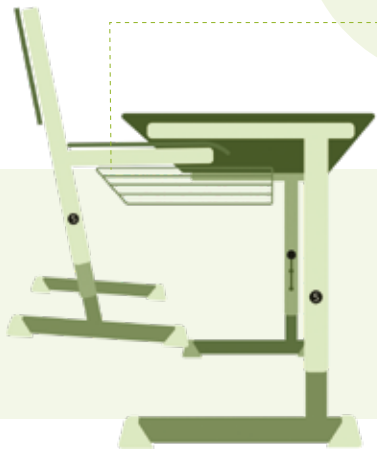
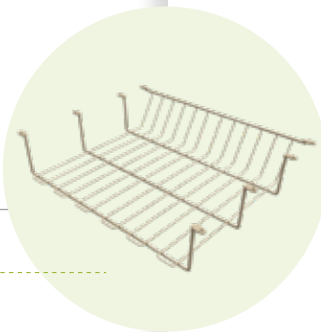

*KEX  
teacher's desk  
with drawers*



*KEX  
teacher's chair,  
upholstered*



*KEX  
school chair*

# FRONTAL EDUCATION



## ADVANTAGES OF FIXED HEIGHT FURNITURE IN FRONTAL EDUCATION?

Frontal class work strengthens the competitive spirit on a given topic, and prepares for debates.

The typical teaching methods of this type of organisation are lecture, demonstration and explanation, is assisted by our learning furniture.

A photograph of a modern classroom with rows of white desks and colorful (red and blue) chairs. The room has white walls and a wooden floor. The text 'FIXED HEIGHT PRODUCT COLLECTIONS' is overlaid on the bottom left of the image.

**FIXED HEIGHT**  
PRODUCT COLLECTIONS



KEX FIX



## KEX FIX DESKS FOR ONE OR TWO PERSONS

The table frame is made of 50x25 mm flat oval steel tubes, welded, with bag hooks, and powder coated surface, finished with plastic leg gliders and end caps.

It is made according to the desired standard age group sizes.

The table top measures 70x50 cm or 130x50 cm, available in different materials.

Chair frame is made of 38x20 mm flat oval tubes with welded construction, powder coated surface, plastic foot gliders and end caps. The chairs are stackable, or can be placed in the table's book holder rack.

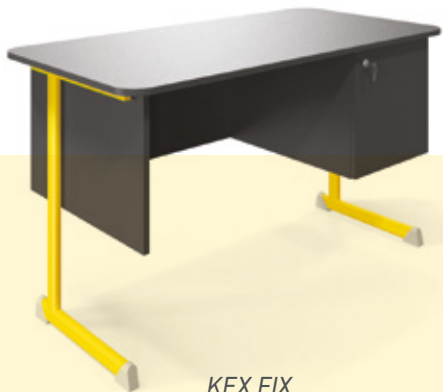

*KEX FIX  
teacher's desk  
with lockable cabinet*



*KEX FIX  
teacher's chair,  
upholstered*



*KEX FIX  
school chair*



*KEX FIX  
school desk*



GEO LINEA

Harmonic lines, various product range and colour options.

A proven furniture range, that fits in the modern look of a premium classroom. The rounded table corners provide increased safety.

The robust frame construction and multiple chairs to choose from, makes it easy to be tailored to the needs of the users.

Cost-effective solution for premium school furniture category.

The desk's solid frame structure is identical to the Geo base model, and harmonious with all the chairs in the collection.

## GEO LINEA DESKS FOR ONE OR TWO PERSONS



*GEO LINEA  
teacher's desk  
with lockable cabinet*



*GEO 1  
school chair*

*GEO 2  
school chair*

*GEO 2 SWIVEL  
school chair*

*GEO PLASTIC 2  
school chair*

*GEO ERGO SOLIWOOD  
school chair*

*GEO FLEX  
school chair*



GEO SPECIAL

GEO SPECIAL DESKS FOR ONE OR TWO PERSONS

Unique look, rounded table edges. Made according to the desired standardized age group sizes.

The desk frame is made of 50x25 mm flatoval steel pipe bent to "C" shape format. Powder coated finish and plastic floor gliders.

The chair with a cantilevered design can also be placed under the table into the book holder rack.

The table top measures 70x60 cm or 130x60 cm, available in various materials. Also available with bag hook on request.

Optionally available, chair or book holder rack

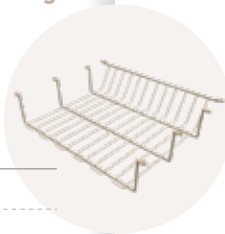

Rounded corners, safer shape!

Immersed seating surface

Book holder rack: also the chair can be placed in it for easier floor cleaning

60x20mm rectangular steel pipe



*GEO SPECIAL school desk*



*GEO 1 school chair*



*GEO PLASTIC 2 school chair*



*GEO ERGO SOLIWOOD teacher's chair, upholstered*



*GEO FLEX teacher's chair, upholstered*



*GEO EXTRA PLASTIC teacher's chair*



*GEO 2 teacher's chair, upholstered*



ATLAS

**ATLAS DESKS FOR ONE OR TWO PERSONS**

**Classic shape, high stability.**

The Atlas table frame is made of 50x25 mm flatovaland tube, the chair frame made of 30x15 mm steel pipes with anti-slip plastic end caps.

The standard desk tops are made of 18 mm laminated chipboard with a 2 mm ABS edge sealing, in your choice of colour.

Optionally, with book holder rack or book holder box.

plywood seat and backrest

on both sides  
bag hooks

Optionally available  
chair or book holder rack



stable frame  
38x20 mm flat oval steel pipe



ATLAS  
teacher's desk  
with drawer



ATLAS 1  
school chair



ATLAS 2  
school chair



ATLAS  
teacher's chair



ATLAS ERGO 1  
school chair



ATLAS ERGO 2  
school chair



ATLAS ERGO  
teacher's chair

# GROUP EDUCATION







# FIXED HEIGHT

## PRODUCT COLLECTIONS

## WHAT ARE THE ADVANTAGES

OF FIXED HEIGHT

FURNITURES IN GROUP TEACHING?

For smart classrooms and digital environments our furniture collections can be found in this topic.

Our aim is to support you to find educational environments that will help to create more interactive and flexible learning spaces by using our furniture.



FRISBEE

Collaborative, flexible spaces,  
many opportunities!

Frisbee desks are designed  
for group work. Desks can be  
rearranged in several layout as  
required.

Teaching and learning has  
definitely changed.

Our furniture supports the goal of  
being a highly collaborative, and  
offers flexible space for students  
and teachers.

### FRISBEE DESKS, RIGHT OR LEFT

● rounded table top corners

● height levelling  
plastic insert glides



● robust frame,  
30 mm diameter steel tube

### IDEAS FOR SPACE PLANNING

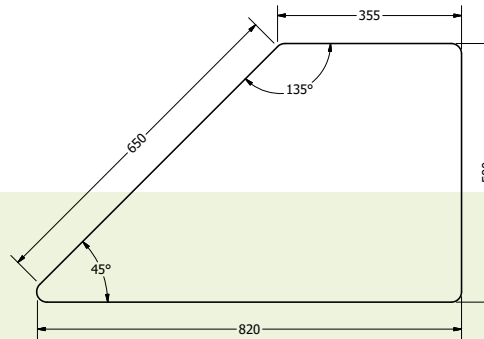

FRISBEE RIGHT SIDE  
student desk

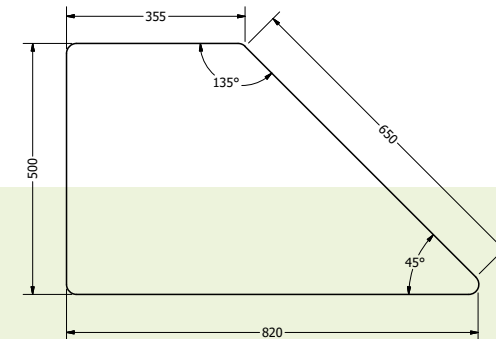

FRISBEE LEFT SIDE  
student desk

Gratnells



FLEX

FLEX SINGLE AND TWO PERSON DESKS AND FLEX CHAIRS

High mobility brings versatility!

Our ongoing furniture developments create space, allow institutions to find the most suitable solution for them, even multifunctional school furniture for all day education ensure a smooth running of the whole day.

Essential for modern learning is the need for differentiation in the classroom, which implies that school furniture must meet both individual and group work.

For this differentiation, the furniture is arranged spatially, this requires a need of ease of movement and combination, functionality, ergonomics, and rangeability.



stackable,  
solid frame

Flex seating shell  
with a wide range of colours



FLEX  
teacher's desk  
with Gratnells drawers



FLEX „C“  
school chair

FLEX „C“  
teacher's chair

FLEX „D“  
school chair

FLEX „D“  
teacher's chair

FLEX  
school chair

FLEX  
teacher's chair



# TRAPEZOID AND HEXAGON

Our stackable trapezoid and hexagon tables can be easily configured in a row, offering limitless possibilities for active learning and teaching that demand flexibility.

We understand that adapting to student-centered learning is crucial, which is why our furniture is designed with this in mind. The stackable trapezoid and hexagon desks can be rearranged in a matter of moments, providing unmatched versatility.

Flex, Trapezoid and Hexagon desks support the improvement of student communication skills, conflict management and enhanced student productivity.

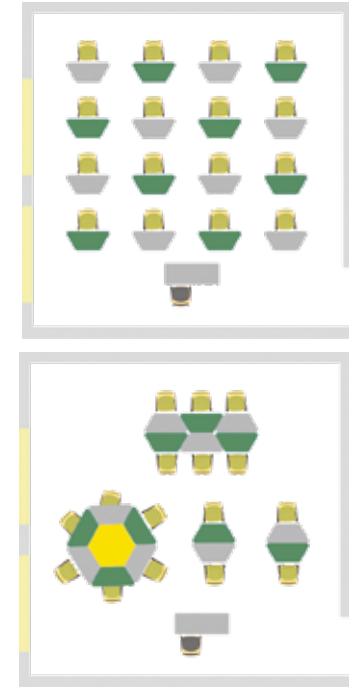

HEXAGON DESK  
stackable



TRAPEZOID DESK  
1 person,  
sortable in row



TRAPEZOID DESK  
with castors, 1 person,  
sortable in row



TRAPEZOID DESK  
1 person, stackable,  
sortable in row



TRAPEZOID DESK  
with castors, 1 person,  
stackable, sortable in row



# SMART CLASSROOM



## Innovative and flexible!

Our smart classroom solutions bring together furniture, tools, software, and teaching methods in perfect harmony.

Teaching and learning have no obstacles with our smart classroom furniture, making the work enjoyable.

In the classrooms of the 21st century, we foster critical thinking, creativity, teamwork, digital competence, hands-on experiences, and active learning.

## IDEAS FOR SPACE PLANNING

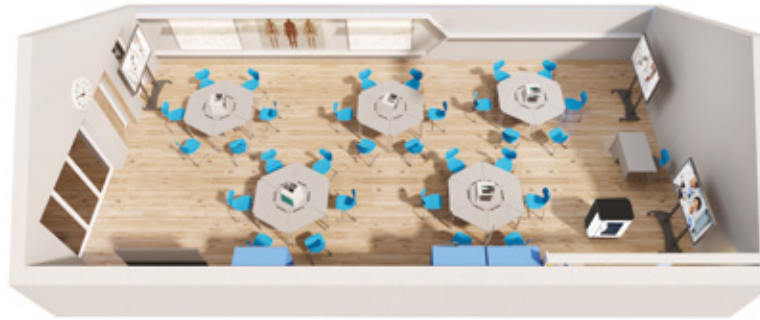

hidden castor feet



HEXAGON DESK  
smart classroom



TRAPEZOID DESK  
smart classroom

# TABLES



KALEIDO

Individual and group work has never been so easy!

Introducing Kaleido Puzzle furnitures with multiple variations.

Inspired by the variety of kaleido puzzles, our Kaleido collection features desks and chairs with convex and concave shapes, offering flexible room arrangements for group work.

## IDEAS FOR SPACE PLANNING

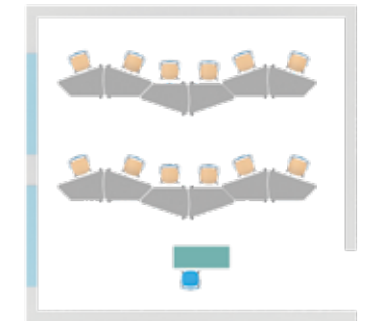
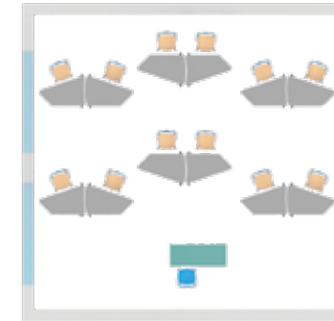
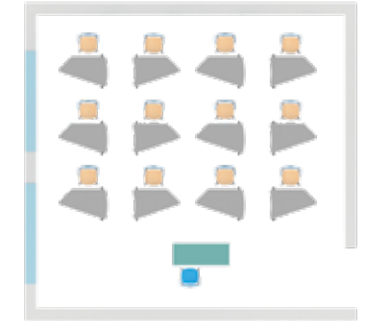
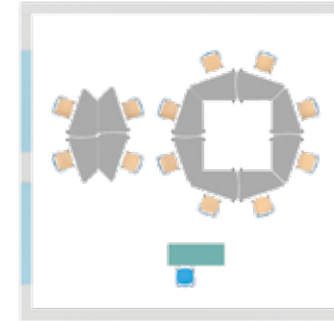
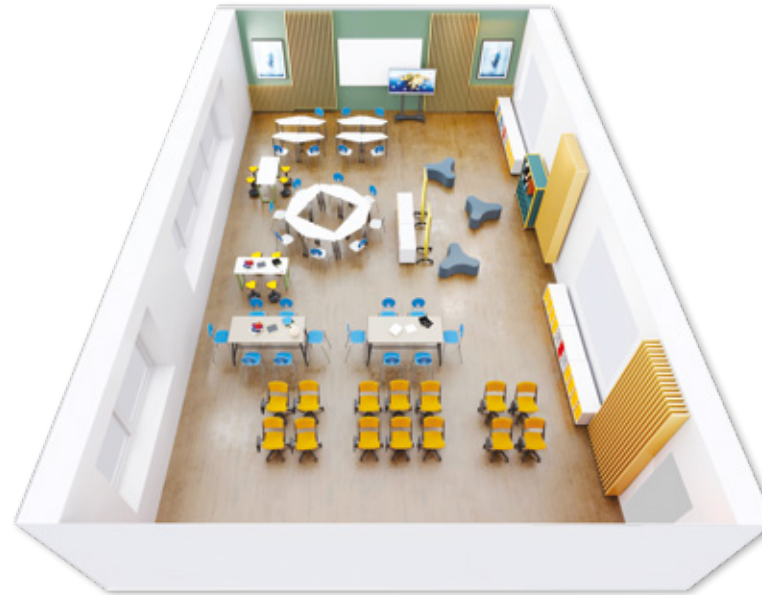

*KALEIDO LECTURE TABLE*  
height adjustable



*KALEIDO CONVEX*  
single student desk



*KALEIDO CONCAVE*  
single student desk



*KALEIDO*  
teacher's chair,  
upholstered



*KALEIDO*  
school chair



PITAGORAS

Discover our Pitagoras tables designed for versatile communal spaces like libraries, language instruction areas, and study rooms, where the ability to quickly change the layout is crucial for accommodating both individual and group activities.

Thanks to the castors, our furnitures can be effortlessly relocated.

Due to the durability of HPL material, you won't have to worry about tabletop edges breaking or splitting when arranging and moving the tables. Plus, the table surfaces are highly resistant to scratches, ensuring long-lasting quality.

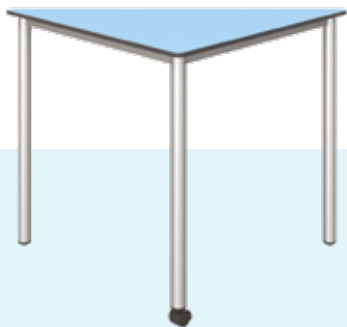
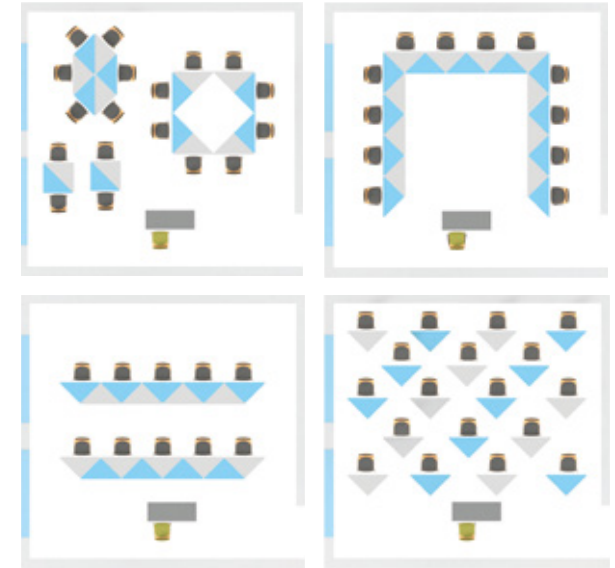

PITAGORAS TRIANGLE  
student desk



PITAGORAS SQUARED  
student desk



PITAGORAS RECTANGULAR  
student desk



# PUZZLE WAVE

Inventive and dynamic.

Create your ideal learning environment with our Puzzle Wave desks.

Enhance modern learning and group projects with quickly and easily variable desks

## IDEAS FOR SPACE PLANNING

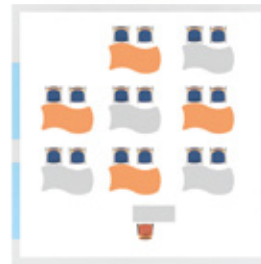
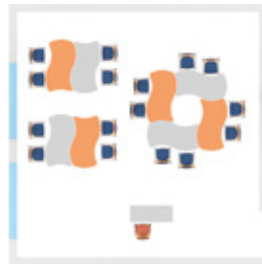
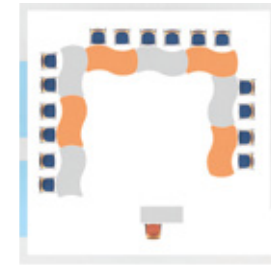
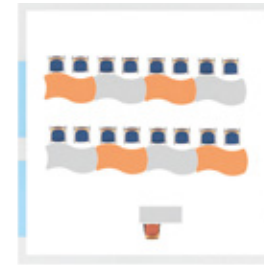

PUZZLE WAVE RECTANGULAR  
student desk

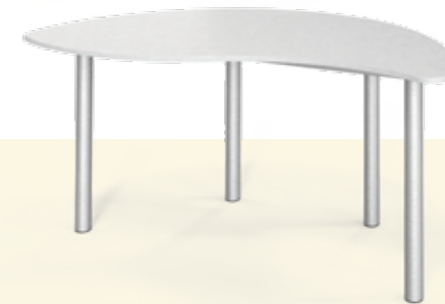

PUZZLE WAVE HALFRound  
student desk



**TEACHERS**  
DESKS AND CHAIRS





## WELCOMING SPACES FOR TEACHERS

TO WORK INDIVIDUALLY AND IN TEAMS

We have also designed furnitures for teachers' rooms, in mind where teachers can relax, have a coffee, but most of all, where they can prepare their lessons, correct the exams or have a meeting with their colleagues.

The furnishing of usually cramped and crowded spaces with practical and multifunctional furniture is a crucial point. With our innovative products workstations, ergonomic seating and desks with drawers can be integrated.



*MANNEQUIN POP teacher's chair  
upholstered*



*BOTOND SOLIWOOD teacher's chair  
upholstered*



*FLEX teacher's chair  
upholstered*



*FLEX SWIVEL teacher's chair  
upholstered*



*ZEBRA POP teacher's chair  
upholstered*



*ATLAS ERGO teacher's chair  
upholstered*



*FLEX "D" teacher's chair  
upholstered*



*FLEX SWIVEL teacher's chair  
footrest, upholstered*



*ZEBRA POP teacher's chair  
upholstered, skid legs*



*SOLIWOOD ERGO teacher's chair  
upholstered, skid legs*



*FLEX "C" teacher's chair  
upholstered*



*MULTI SWIVEL teacher's chair  
upholstered*

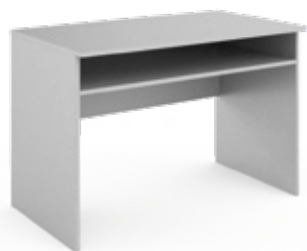

*IA WITH SHELF  
teacher's desk*

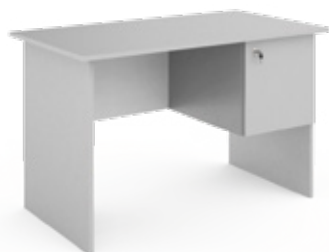

*IA with SIDE CABINET  
teacher's desk*



*DUBLE 90-90  
double-sided teacher's desks*



*FLEX  
double-sided teacher's desks*



*IA-2 WITH DRAWER  
teacher's desk*

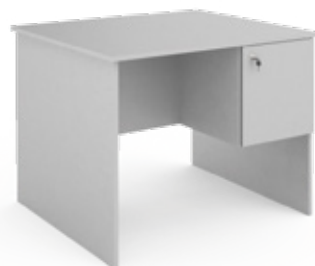

*SAVARIA 1  
double-sided teacher's desks*



*DUBLE 100-100  
double-sided teacher's desks*



*FLEX 2  
with drawers teacher's desk*



*SAVARIA 2  
double-sided teacher's desks*



*IA 3 WITH DRAWERS  
teacher's desk*



*DUBLE 120-120  
double-sided teacher's desks*



*FLEX 3  
with castor cabinet teacher's desk*

# TEACHER'S DESKS



## STRUCTURED PRACTICAL

### AND WELL ORGANIZED STORAGE

Our FLEX cabinets are made up of modular units. With our products you can design your practical storage systems for classrooms.

Well-organised filing and and easy to use storage.

Some models are available with castors which allows you to rearrange your spaces in a moment.

In case of cabinet corpus, you have the choice of various laminate colours. 7 different colours are available to choose from, when it comes to plastic Gratnells drawers.

The text "FLEX CABINETS" is in a large, bold, white sans-serif font, with "WITH GRATNELLS DRAWERS" below it in a smaller, white sans-serif font. The text is overlaid on a blue circular graphic element.

**FLEX CABINETS**  
WITH GRATNELLS DRAWERS



## OUR SPECIALITY

---

CABINETS MADE FOR DIFFERENT  
STORING PURPOSES

Whether classrooms or offices, our multifunctional lockers are a perfect fit.

The body and doors are made of 18 mm laminated chipboard with ABS edge sealing. With fixed height shelves, back panel made of 4 mm white HDF board.

Fitted with handle and lock.



**CLASSIC**

CABINETS

# SCHOOL

---

## BOARDS

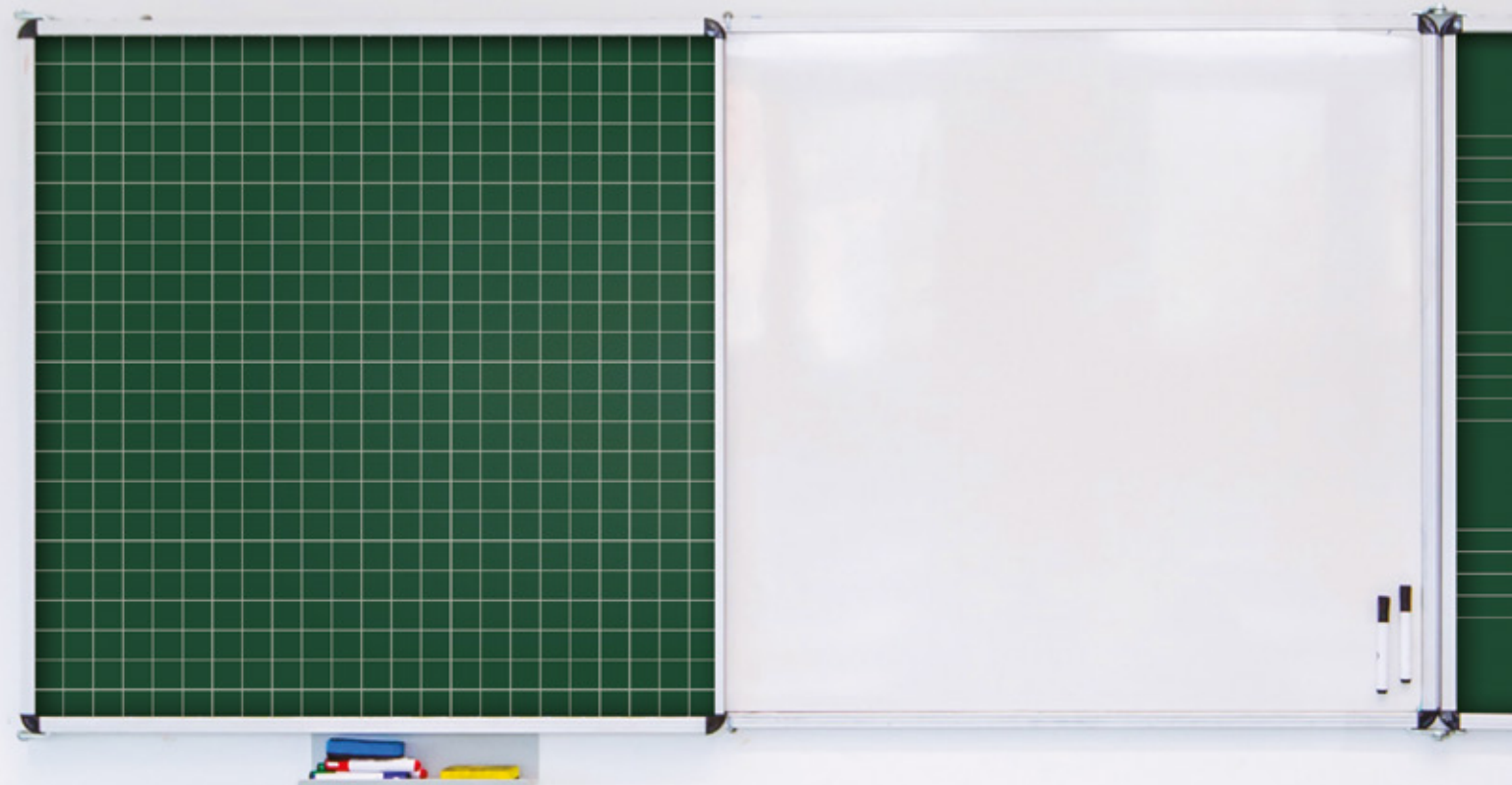



## SCHOOL BOARDS

---

### ESSENTIAL TOOLS FOR EDUCATION

School boards and accessories are crucially essential to aid visual demonstration in classrooms.

We offer a variety of models from squared to double winged boards as well as mobile versions, that are suitable for both chalk and marker use, so every educational institution can find what they need.

Wall boards, board stands and pedestal boards are colouring our product range as well.



$$W = \int_{V_1}^{V_2} p(V) dV$$

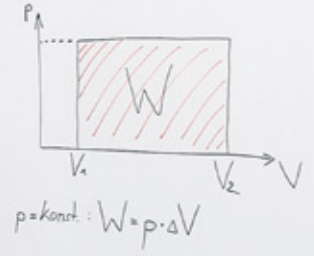

CLASSIC ENAMELLED STEEL WALL BOARD  
Side-winged

CLASSIC

The boards are fixable with screws and dowels.

Can also be mounted on a mobile stand, making the board surface rotatable.

MODELS THAT CAN BE WRITTEN WITH MARKER PEN AND CHALK,  
ALSO AVAILABLE IN SQUARE AND DOUBLE WING VERSIONS



The **Classic Board's** frame is 15 mm wide powder coated aluminium, Made of U profile, closed with plastic components at the corners.

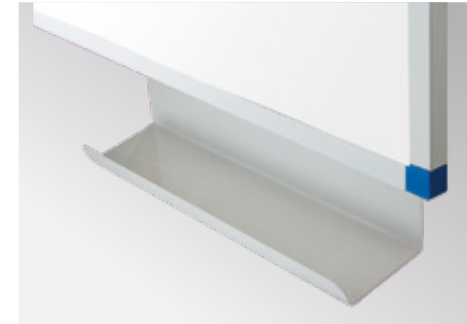

The ceramic-steel and enamel-steel chalkboards come with **chalk holders**.



CLASSIC BOARD  
on a mobile stand

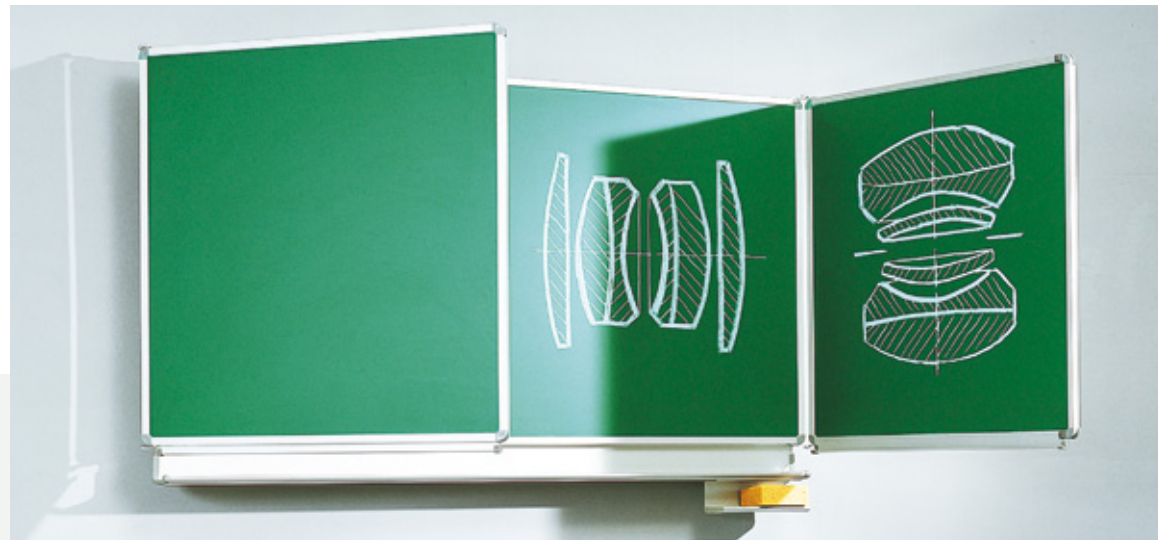

CLASSIC CERAMIC STEEL WALL BOARD  
side-winged

# VARIO



VARIO WALL BOARD  
vertically movable

The Vario counterweighted wall board is attachable to the ground or wall by fixing the column stand with hidden screws, or by using a console.

MULTIPLE SURFACES - SIMULTANEOUS MOVEMENT, EVEN IN OPPOSITE DIRECTIONS



*VARIO WALL BOARD  
with electric column stand*



*VARIO WALL BOARD  
with counterweighted column stand*



*VARIO WALL BOARD  
with freely moveable column stand*



*MTA UNI-1 BOARD STAND  
with castors*



*ROTATABLE STANDING TABLE  
ceramic-steel and enamel-steel*



*FLIPCHART BOARD*



*MOTORISED INTERACTIVE WALLBOARD  
with remote control*



*MOTORISED INTERACTIVE MOBILE STAND  
with castors and remote control*

FABRIC-COVERED AND CORK-SURFACED BOARDS

The polystyrol underlayer grants a more stable pinning surface.

Fabric message board  
COLOR SAMPLES



Puma blue



Puma red



Puma gray



Puma Yellow

STARTER KITS  
included with the boards

CORK-SURFACE BOARDS:  
100 pins, dowels, screws

FABRIC COVERED BOARDS:  
100 pins, dowels, screws



MESSAGE BOARD  
with fabric cover



MESSAGE BOARD  
with cork surface

# MESSAGE BOARD

# MODULAR





The modular display system is the perfect tool for setting up mobile installations and exhibitions quickly.

The swivelling board modules and the T-profile legs allow you to configure flat and spatial display systems for your exhibitions

For larger spaces, display-islands can be established.

The modules can be easily rearranged after assembly, using the T-stands optionally equipped with castors.

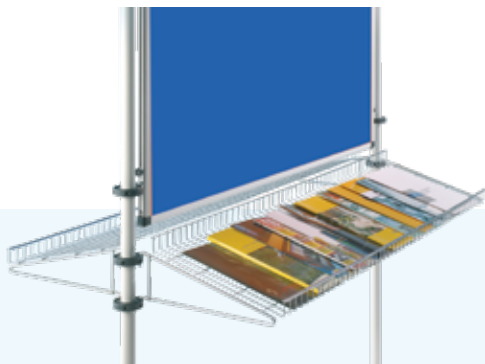

*BROCHURE STORAGE*  
120 cm wide

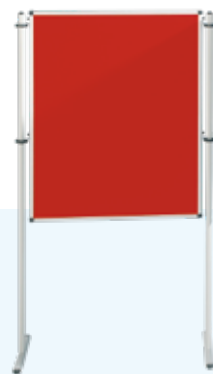

*S-BOARD MODULE*  
120 cm

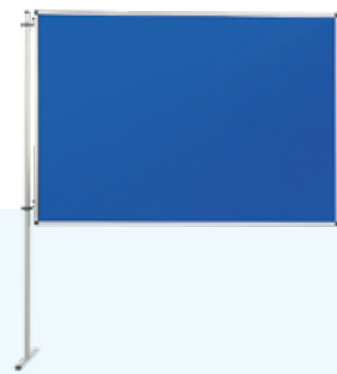

*M-BOARD MODULE*  
150 cm



*L-BOARD MODULE*  
170 cm



**SPECIFIC  
CLASSROOM**  
FURNITURES



## SPECIAL FURNITURES

FOR CREATING  
CLASSROOMS THAT MEET  
UP TO DATE EDUCATIONAL NEEDS

We also manufacture special equipment for laboratories, technical workshops, IT and drawing rooms to help skill- and competency development.



# SCIENCE

Our utility supply system provides an optimal solution for electrical, water, sewage and gas services for up to two workstations at the same time.

The safety of these electrical installations is guaranteed by emergency stop button, voltage indicator light, waterproof switch cabinet, as well as built-in small circuit breakers and contact protection Fi-Relé.

## CUSTOMISABLE SUPPLY SYSTEMS



**PREMIUM CHEMICAL CABIN**  
*one sided*



**SINGLE PERSON LAB DESK**  
*with shelf*



**TWO PERSON LAB DESK**  
*with shelf*



**THREE PERSON LAB DESK**  
*with shelf*



# ARTS WORKSHOP

Special furnitures are essential for the specialised classrooms.

For arts workshops we also manufacture specialised furnitures.

Our experts will help you find the right right design.

## TOOLS FOR CREATIVE ACTIVITIES

drawing sheet cabinet



10 drawer organiser storage



*DRAWING TABLE*  
with sheet holder,  
adjustable and tiltable



*GEO ARTHORSE*  
melamine top



*FLEX STUDENT CHAIR*  
adjustable footrest

# FURNITURES



**OFFICE**  
FURNITURE





## UNIQUE & HIGHLY EFFICIENT OFFICE

TAILORED TO REQUIREMENTS

During design phase, we take into account in what type of environment office workers can do their job efficiently. Maintainable and smart office layouts.

Choose from our furniture range, and customise work environments for your individual needs.

During furnishing, we offer convenient options for arranging network cables and electrical wiring with mainline tools. Additionally, we modernise phone charging with built-in chargers.



# PONTIS

For us, the office is not only a place for work, it is also a stage for creativity and teamwork.

**TO LET THOUGHTS OPENLY FLOW, WE NEED TIDINESS AROUND US.**

**That is what the Pontis cabinet is best at: items, items not used at a time has to be stored orderly, whilst managing accessibility.**

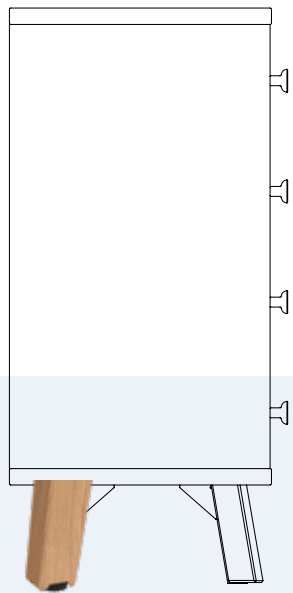

OAK legs

## WE BROUGHT NATURE INTO THE OFFICE

Storage sizes of the Pontis cabinet were designed with the standard folder height in mind.

Cabinets are available in full laminated door, glass door & drawer, and wardrobe versions.

Lower Pontis sideboards open up space creating a warmer and more welcoming interior.



# CABINETS



PONTIS

## THE NEW DESIGN

The main principle behind the design of the Pontis Collection is to furnish multifunctional spaces with visual integrity.

By the natural textures of oil treated solid wood legs we bring nature in the office. Combining organic wood with steel creates a perfect combination and a lively environment.

## SYMMETRICAL OR ASYMMETRICAL DESK

The legs of the Pontis desk have an angle of 75 degrees to the top.

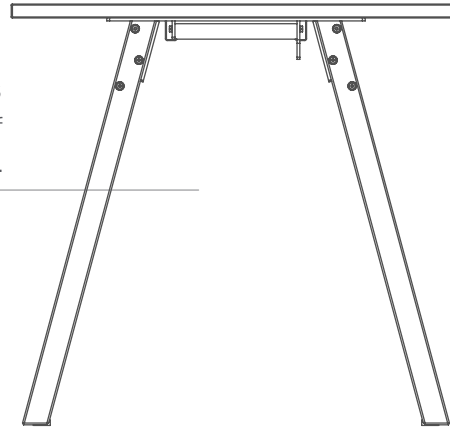

90 angle and 75 angle

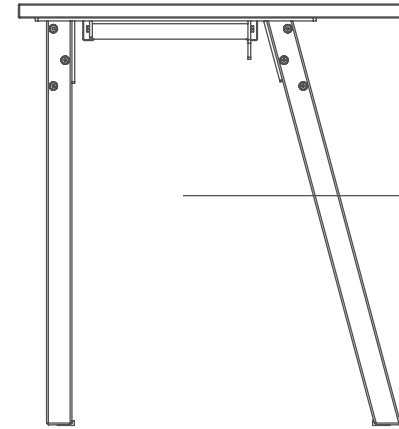

complementary products  
PONTIS metal small drawer

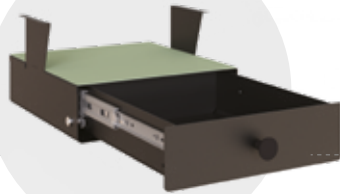

NEO  
office chair



PONTIS DESK  
symmetrical



PONTIS MEETING TABLE  
oval



PONTIS MEETING TABLE  
rectangle

# FLYNN



A playful, lightweight design for creative thinking.

### HARMONIC DESIGN

Wide selection of components, unlimited variation possibilities.

**OPTIONAL ACCESSORIES:**  
front panel, screen, tidy cable, wireless charging pad

MANY SIZES, NEW SHAPES AND SELECTION OF COLOURS

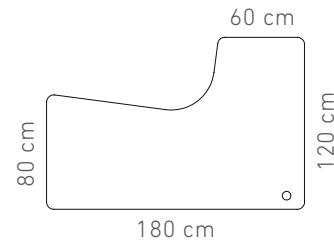

FLYNN OFFICE DESK  
"L" left return

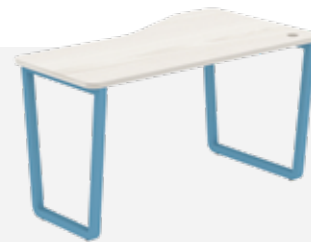
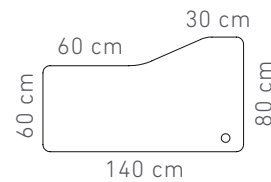

FLYNN OFFICE DESK  
left side curved

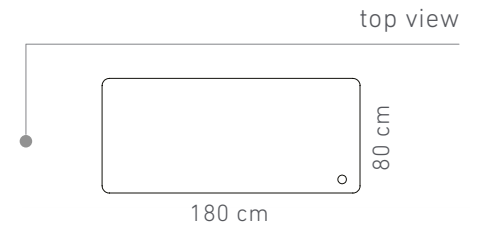

FLYNN OFFICE DESK  
rectangular



FLYNN  
container



# ELIX STRONG



The ELEX height adjustable desks designed...

...FOR FLEXIBILITY AND ERGONOMIC COMFORT.

The dual-motor system provides faster movement and stability.

FOR HOME AND OFFICE, STANDING OR SITTING USE

125 cm

- stepless height adjustment
- dual-motor system

60 cm

- One-touch, 3 bank memory
- Safety stop mechanism, with collision detection.



*ELEX OFFICE DESK  
with 2 motors for adjustable height*



*ELEX OFFICE DESK  
return desk, adjustable height*



*ELEX STRONG OFFICE DESK  
double-sided, adjustable height*



**RELAX**

WORK CAFE



## SPACES DESIGNED TO HELP YOU GROW RECHARGE

No longer just a place to eat lunch and grab a coffee, the workplace café also serves as an area for collaboration and informal meetings.

Mobile technology makes it easier to work from anywhere, casual lunch conversation can easily turn into a brainstorming session.

Cafés need to be designed to accommodate changing work styles.



# CANTEEN

**WHEN AN EMPLOYEE TAKES TIME  
TO RELAX AND EAT.**

**Informal relationships between colleagues strengthens motivation and productivity.**

**Furthermore, the office canteen provides an excellent opportunity to enhance the company's identity and the relationship between employees and employers.**

**Here, the professional hierarchy can loosen up, allowing ideas and creativity to flow more freely.**

**CREATIVE SOLUTIONS**



# COFFEE STATION



**MODULAR**  
STORAGE FURNITURE



## ADVANCED STORAGE SYSTEM

MANY POSSIBILITIES

An excellent storage solution for locker rooms, work areas, dining rooms or community spaces. A popular solution among employees and employers.

With the combination of the standard size compartments and variable height units, you can create the most suitable combination adapted to different needs and characteristics.



# CUBE LOCKER



## MODULAR SYSTEM

Alex Furniture presents its newest cabinet module system, which provides a solution to any storage problem.

### YOU DREAM IT

Thanks to a special, new technology, the melamine surface became printable.



CUSTOMISED GRAPHICS

THERE WILL BE ORDER!



AVAILABLE COLOURS

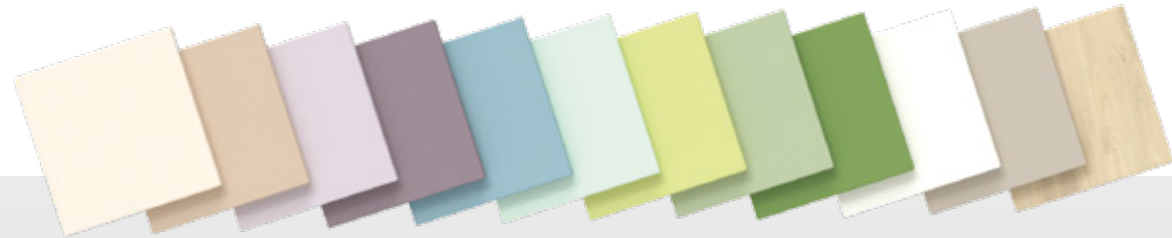

# STORAGE

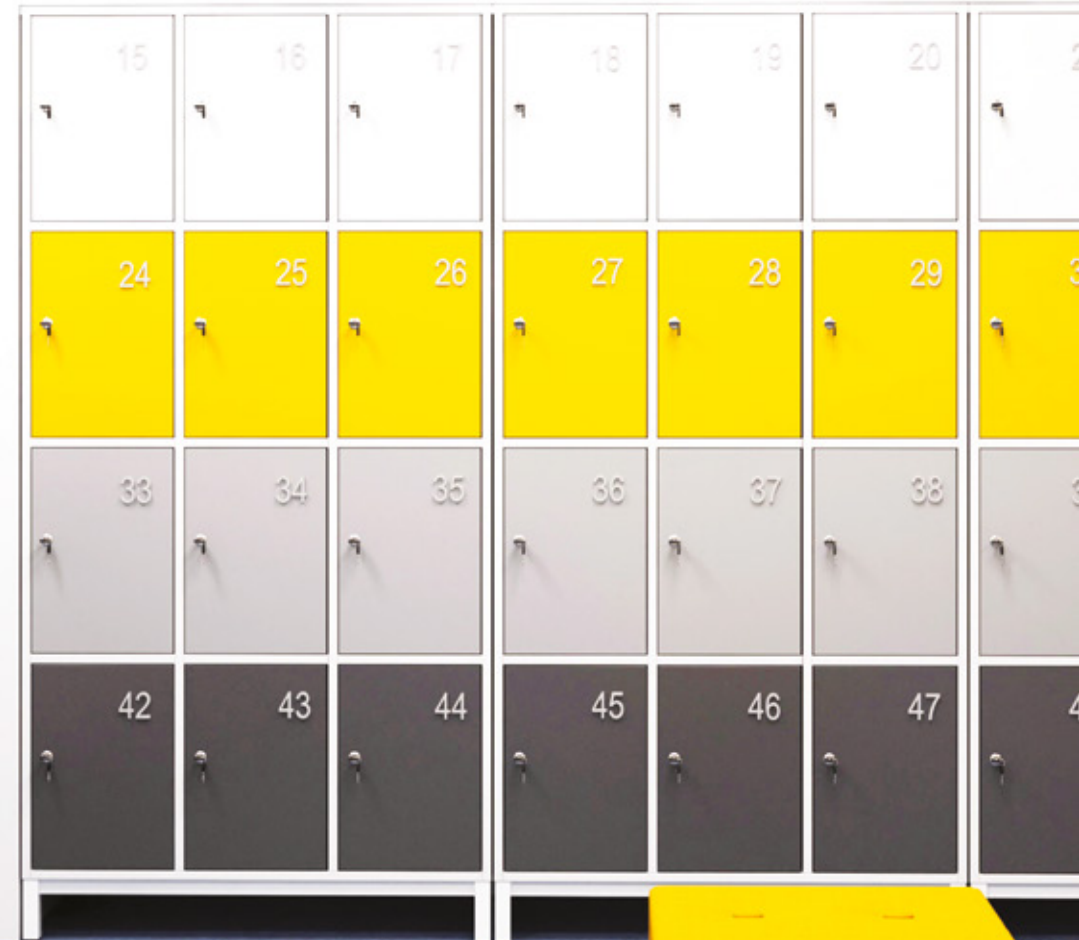

# LOCKERS

MELAMINE FACED CHIPBOARD



## STABLE AND SAFE

WITH TWO KEY SECURITY LOCK

Our safe deposit boxes are perfect storages. When placed in the right space, it provides an individual storage option. It is made of melamine-faced chipboard.

The standardised 52 cm deep cupboards fit easily even in narrow spaces.

The back panel is made of solid chipboard, which makes the cabinet extremely stable and safe.



## UNIQUE SOLUTIONS

PRACTICAL DESIGN



# FITT LOCKER

MELAMINE FACED CHIPBOARD

The affordable cabinets are available to our customers in a wide range of colors and types.

The collection is highly customisable to meet different design expectations allowing to shape your own environment.

# FITT WITH SHOE STORAGE

LOCKER





## PRINTABLE FURNITURE SURFACES

WE MAKE YOUR DREAMS COME TRUE

A practical, space-saving wardrobe that meets all needs: it has a dedicated place for clothes, shoes and also accommodates a seating surface.

Shoes can be stored separately in the lower part.

Dream up your own graphic design and have it printed on the doors. A company logo, special locker numbering or a motivational print: various possibilities.



# COMMON AREA

LOUNGE FURNITURES





## CREATIVE AND PRACTICAL

### OPTIMAL USE OF SPACE

Our environment constantly affects us. Every day shape our thinking and behaviour - even if we are not aware of it.

All of our products are suitable for furnishing reception areas, corridors, locker rooms, offices and lobbies.

We have designed furniture that fits well with each other, so there are countless variation options available for optimal use of space.



PONTIS

## NATURAL DESIGN

The overall impression is often determined by small details.

The natural oak wood legs give the table a unique look, brings nature closer and give a feeling of fine luxury.



PONTIS  
coffee table

## MULTIFUNCTIONAL TABLE



Flexible usage:  
community space,  
meeting and dining room



minimal design



Universal look.  
It adapts well to any style.



BEAN

COMFORTABLE, FUNCTIONAL  
AND PRACTICAL

Comfort and design in the reception area, community space, office or meeting room.

Relax spot for taking a break, for tasks requiring concentration or for a phone call.



BEAN armchair with screen  
DROP table

FREEDOM IN OPEN SPACE

BEAN LOBBY PLUS with screen  
AB-LUX table



BEAN sofa with USB charger  
BEAN table



DOMINO

Our latest development is also unique in terms of material use and appearance.

### CREATIVELY DESIGNED AND WELL FITTED BENCHES

The upholstered foam seat is fixed on a plywood layer. The table surface is a high-quality furniture linoleum giving it a soft touch and antistatic surface. Optional induction charger is available.



narrowed pipe legs  
chrome self-adjusting feet

### COMFORTABLE AND UNIQUE



phone charger  
and USB plug

### AVAILABLE FOR ALL TYPES BENCHES



console table



# LOUNGE



# ATLANTA



ATLANTA is an elegant furniture collection.

MODERN AND ELEGANT



### COMPOSITION OF GEOMETRIC SHAPES

The collection includes tables, armchairs, two- and three-seat sofas and benches.

ATLANTA SOFA  
3 seat,  
powder coated legs



STRIKE TABLE  
with metal leg,  
in different sizes



ATLANTA TABLE  
with metal legs

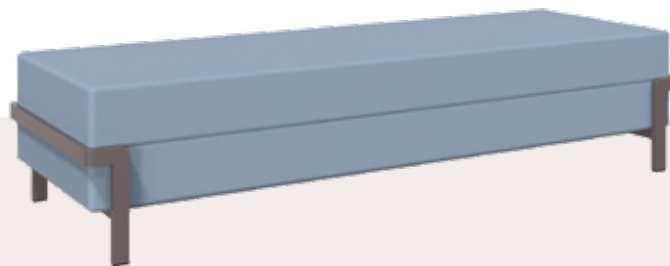

ATLANTA BENCH  
3 seat



ATLANTA ARMCHAIR  
1 seat

# LOUNGE



VITAL

With the lounge elements of our VITAL COLLECTION, locker rooms, hospitality areas and lobbies can also be furnished practically.

#### MODULAR BENCHES AND TABLES

Upholstered sofas can be complemented with benches, stools and low tables.

COLORFUL AND FUN SHAPE



#### COMPLEMENTARY PRODUCTS FOR ALL TABLE



phone charger and USB plug



VITAL STOOL  
Size: Ø54x39 cm

VITAL lounge and coffee table elements



# LOUNGE



# BUBBLES

**COMFORTABLE,  
FUNCTIONAL AND PRACTICAL**

The BUBBLES Collection is the combination of comfort and design in a reception area, community space, office or meeting room.

**INDOOR PLAYGROUND**

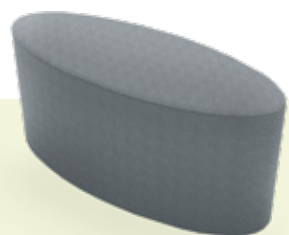

*BUBBLES 4.*  
size: 120x50x53 cm



*BUBBLES 3.*  
size: 136x78x40 cm

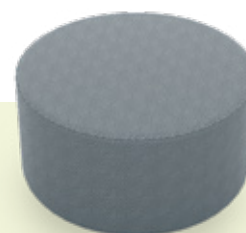

*BUBBLES 2.*  
size: Ø60x30 cm



*BUBBLES 1.*  
size: 125,2x109,5x42 cm



DURAN

**DURAN** products are becoming more and more popular in public spaces, lounges and dining rooms.

**VARIABLE SPACE**

**2 IN 1  
LUNCH AND MEETING AREA**

High tables and bar stools are popular in workplace dining rooms as they offer versatile use.

**DURAN Collection:**  
Tables, benches and stools, in high and regular furniture heights. Available in several sizes, colors and upholstery.



phone charger and USB plug

**OPTIONAL  
FOR ALL TABLES**



*DURAN  
barstool*

legs with castors

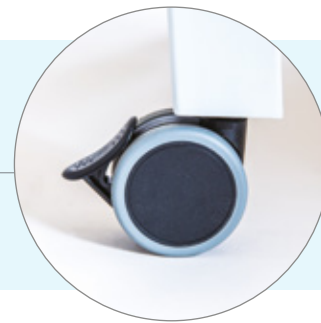

*DURAN  
high table*

# LOUNGE



KOLD



KOLD table multifunctional, meets different needs in any space.

NOT JUST FOR DINING...

The Scandinavian design goes well with any style.

A GREAT COMMUNITY SPACE



CROSS  
barstool and stool

KOLD table  
with CROSS barstool



# LOUNGE



# KALEIDO

The modern-shaped Kaleido chair is produced in many colors.

#### VERSATILE KALEIDO COLLECTION

##### KALEIDO bar stools:

Chair backrest and seat in lacquered beech plywood or HPL covered plywood. Optional upholstered seat pad.



*KALEIDO  
bar stool*

UNIQUE SHAPE, MODERN COMFORT



# LOUNGE



## **DINING**

CANTEEN FURNITURE



## PRACTICAL ARRANGEMENT

EASY TO CLEAN

Canteen furniture has to be durable, easy to clean and rearrange. It is essential to provide a comfortable seat for everyone and an opportunity to relax during a lunch break.



**KALEIDO**

## COLOURFUL DESIGN

### TABLE:

The legs 40 mm diameter pipes, powder coated steel frame, 120 x 80 cm plywood top HPL covered both sides, plastic end cap. size: 120x75x80 cm

### CHAIR:

The legs 18 mm diameter steel pipe with plastic gliders, seat and backrest HPL covered on both sides. size: 52x47x46 cm



II. DINING TABLE  
vandalism-proof

## KALEIDO DINING COLLECTION



KALEIDO  
chairs



BETA



## MINIMAL DESIGN

### TABLE:

18 mm diameter steel pipe frame with plastic end cap. The table top: 1.8 cm melamine-faced chipboard, with ABS edging.

size: 135x75x90 cm

### CHAIR:

The legs is a 12 mm diameter steel pipe, powder coated, upholstered seat and backrest.

size: 52x47x46 cm



*BETA*  
dining table

## BETA DINING COLLECTION



*BETA*  
chairs

FLEX FLEX  
FLEX



FLEX

**VANDALISM-PROOF  
ERGONOMIC DESIGN**

**TABLE:**

The legs 30 mm diameter powder coated steel pipe frame, plywood table top decorated on both sides. size: 120x75x80 cm

**CHAIR:**

The legs 18 mm steel pipes, powder coated, unbreakable plastic shell. Size: 55x38x59 cm

**FLEX DINING COLLECTION**



*FLEX CHAIR*

*vandalism-proof seat shell, spider legs*



*FLEX CHAIRS*

*various colours*



REAL

## DISTINCT SHAPES

### TABLE:

Melamine-faced chipboard table top, tapered legs, powder-coated steel frame. size: 120x75x80 cm

### CHAIR:

Electrostatically powder-coated steel frame, tapered legs, plywood seat and backrest. size: 52x47x46 cm



*REAL  
dining table*

## REAL DINING COLLECTION



*REAL  
chairs*

# CUSTOM FURNITURE DESIGN

---



**DESIGN YOUR FURNITURE  
WITH OUR SUPPORT!**

# AGE GROUP CHART



At Alex Féműtor we follow **European Standard UNE-EN 1729 for schools** (chairs and tables for educational institutions), in which the functional dimensions (part I) and safety requirements (part II) of school furniture are regulated.

	1	2	3	4	5	6	7
Age of Child	AGE: 3-4	AGE: 4-6	AGE: 6-8	AGE: 8-11	AGE: 11-14	AGE: 14+	AGE: 16+
Child height	96 cm - 108 cm	108 cm - 121 cm	119 cm - 142 cm	133 cm - 159 cm	146 cm - 176 cm	159 cm - 188 cm	174 cm - 207 cm
Seating height	28 cm	30 cm	34 cm	38 cm	42 cm	46 cm	50 cm
Table height	50 cm	53 cm	58 cm	64 cm	70 cm	76 cm	82 cm

## LAMINATED CHIPBOARD

	<b>515</b> Light Arden Pine		<b>U15559</b> Pastel Yellow		<b>U18059</b> Gentian Blue		<b>17500</b> Carmine
	<b>24029</b> Fjord Beech		<b>U15246</b> Mango		<b>U18068</b> Heaven Blue		<b>644</b> Beige
	<b>577</b> Sonoma Oak		<b>U15579</b> Yellow		<b>U18079</b> Pacific		<b>314</b> Light Grey
	<b>551</b> Dark Plum		<b>U16010</b> Orange		<b>U19500</b> Star Fruit		<b>304</b> Aluminium
	<b>586</b> Chocolate Sonoma Oak		<b>U16037</b> Powder		<b>U19501</b> Apple Green		<b>244</b> Petroleum
	<b>404</b> Blossom Cherry		<b>U16001</b> Sand Greige		<b>U19502</b> Grass Green		<b>103</b> White
	<b>401</b> Savaria Beech		<b>U17501</b> Rose		<b>U19503</b> Avocado		
	<b>463</b> European Maple		<b>U17505</b> Plum		<b>U19006</b> Mint		

## POWDER COATED FRAMES AND LEGS

	<b>RAL 1006</b> Maize Yellow		<b>RAL 5021</b> Water Blue
	<b>RAL 1015</b> Light Ivory		<b>RAL 6018</b> Yellow Green
	<b>RAL 1021</b> Colza Yellow		<b>RAL 6021</b> Pale Green
	<b>RAL 2004</b> Pure Orange		<b>RAL 7016</b> Anthracite
	<b>RAL 3020</b> Traffic Red		<b>RAL 7035</b> Light Grey
	<b>RAL 4006</b> Traffic Purple		<b>RAL 9006</b> White Aluminium
	<b>RAL 5024</b> Pastel Blue		<b>RAL 9010</b> White
	<b>RAL 5019</b> Capri Blue		



## HPL CHAIRS AND TABLETOPS



## FLEX SEAT SHELL

### AGE GROUP 6



### AGE GROUP 4



## GRATNELLS TRAY

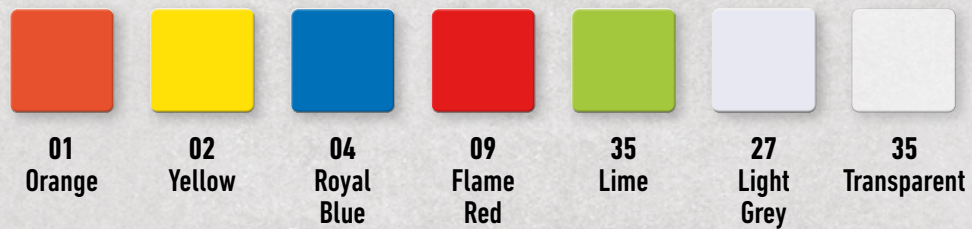

## COMPACT PLATE



# UPHOLSTERY

## DAKOTA FABRIC



S-DA 001

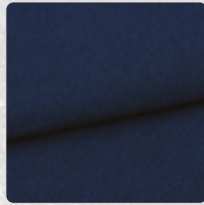

S-DA 008

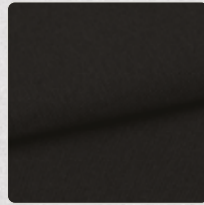

S-DA 100

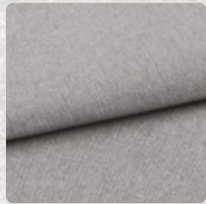

S-DA 003

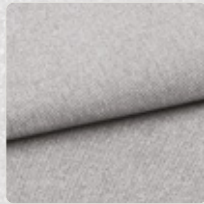

S-DA 010

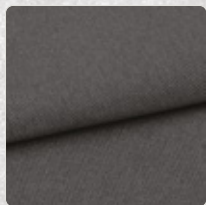

S-DA 013

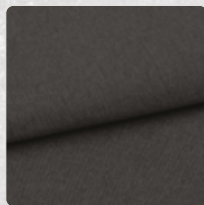

S-DA 014

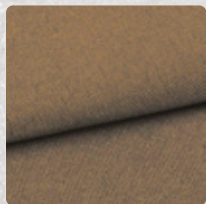

S-DA 024

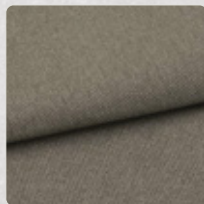

S-DA 091

## OPTIO FAUX-LEATHER

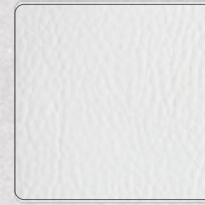

Optio BA1



Optio BE5

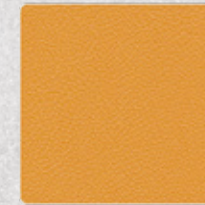

Optio P42

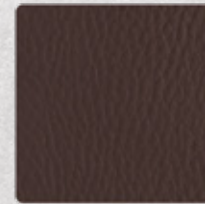

Optio BR2

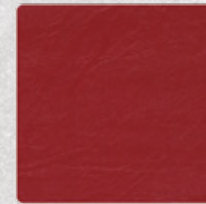

Optio CE2



Optio CZ



Optio F504

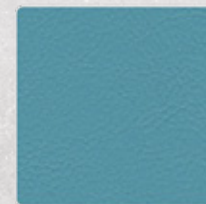

Optio N502



Optio N8



Optio SA3

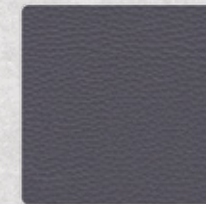

Optio SA4



Optio Z7

## SEALIFE FABRIC



OEKO-TEX®  
CONFIDENCE IN TEXTILES  
STANDARD 100



Sealife 1506

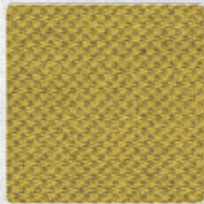

Sealife 3509



Sealife 4522

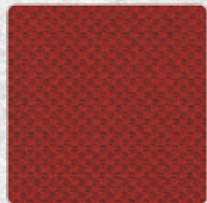

Sealife 4528



Sealife 6512



Sealife 7525



Sealife 8517

## BONDAI FABRIC

OEKO-TEX®  
CONFIDENCE IN TEXTILES  
STANDARD 100

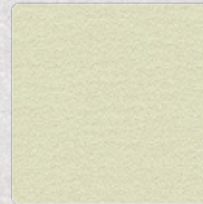

Bondai 1005



Bondai 1008



Bondai 8078

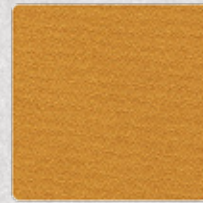

Bondai 3005

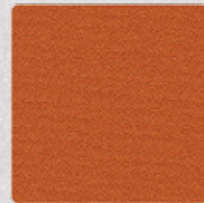

Bondai 3012



Bondai 4007

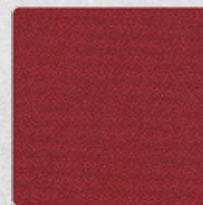

Bondai 4011



Bondai 6006

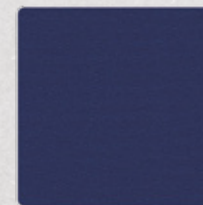

Bondai 6015



Bondai 7008

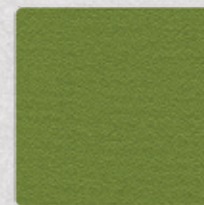

Bondai 7048



Bondai 8010

## ZEN FABRIC

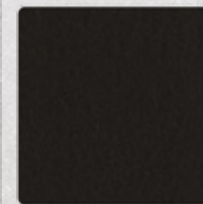

0002



07459

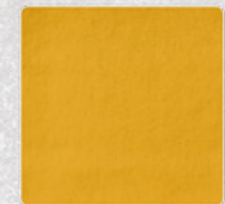

07477

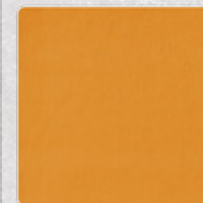

20127



20154

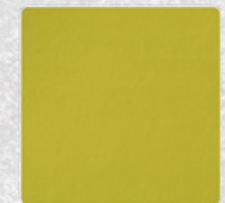

20159

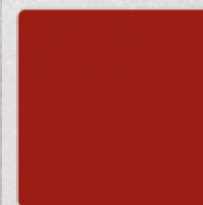

20319

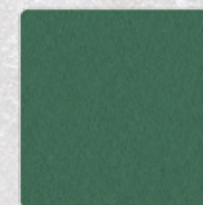

20320

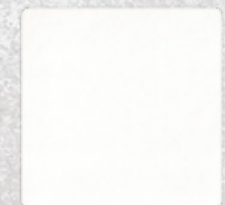

10120



5015

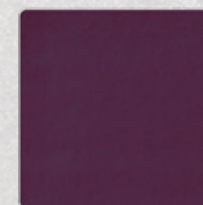

5349

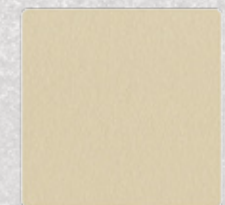

20162



Certified by ISO 9001  
[www.ecomcert.org](http://www.ecomcert.org)

**Export manager:** Yılmaz Yürekli  
**mobil:** +36/20 464-1533  
**e-mail:** [export@alexfurniture.eu](mailto:export@alexfurniture.eu)  
**web:** [www.alexfurniture.eu](http://www.alexfurniture.eu)

---

**ALEX FÉMBÚTOR KFT.**

Magyar utca 21-23.

H-2072 Zsámbék

HUNGARY

